

(1,00 mm) .0394"

# LOW PROFILE & ELEVATED ONE PIECE

## SPECIFICATIONS

For complete specifications and recommended PCB layouts see [www.samtec.com?FSI](http://www.samtec.com?FSI)

**Insulator Material:**

Liquid Crystal  
Polymer

**Contact Material:**

BeCu

**Current Rating:**

2.8 A per pin

(1 pin powered per row)

**Operating Temp Range:**

-55°C to +125°C

**Plating:**

Au over 50µ" (1,27 µm) Ni

**RoHS Compliant:**

Yes

**Processing:**

Lead-Free Solderable:

Yes

**SMT Lead Coplanarity:**

(0,10 mm) .004" max (05-30)

(0,15 mm) .006" max (50)

**Compression Board:**

Gold Pads required

### ALSO AVAILABLE (MOQ Required)

- No alignment pin
  - Top side alignment pin
  - Bottom side alignment pin
  - Other platings
- Contact Samtec.

Choice of board stacking profiles

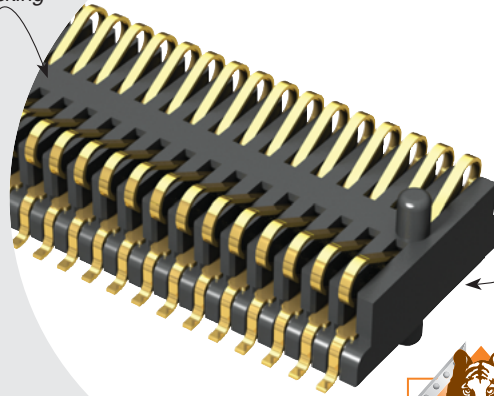

Short version or optional threaded inserts

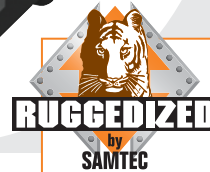

• Threaded insert option

## RECOGNITIONS

For complete scope of recognitions see [www.samtec.com/quality](http://www.samtec.com/quality)



FILE NO. E111594

<b>FSI</b>	<b>1</b>	<b>PINS PER ROW</b>	<b>BODY HEIGHT</b>	<b>PLATING OPTION</b>
<b>10, 20, 30 &amp; 50</b> (Insert/Screw Option) <b>05, 10, 20, 30, 50</b> (Short Version)			<b>-03</b> = 3,00 mm <b>-06</b> = 6,00 mm <b>-10</b> = 10,00 mm	<b>-G</b> = 10µ" (0,25 µm) Gold (-03 only) <b>-L</b> = 10µ" (0,25 µm) Gold on contact, Matte Tin on tail (Not available with -03 body height)

**Note:** Applications requiring 40-50 positions without threaded inserts, please contact Samtec Interconnect Processing Group.

**Note:** Some lengths, styles and options are non-standard, non-returnable.

## Other Solutions

**Low Profile**  
See SEI Series.

**.100" Pitch**  
(2,54 mm)  
See SIB Series.

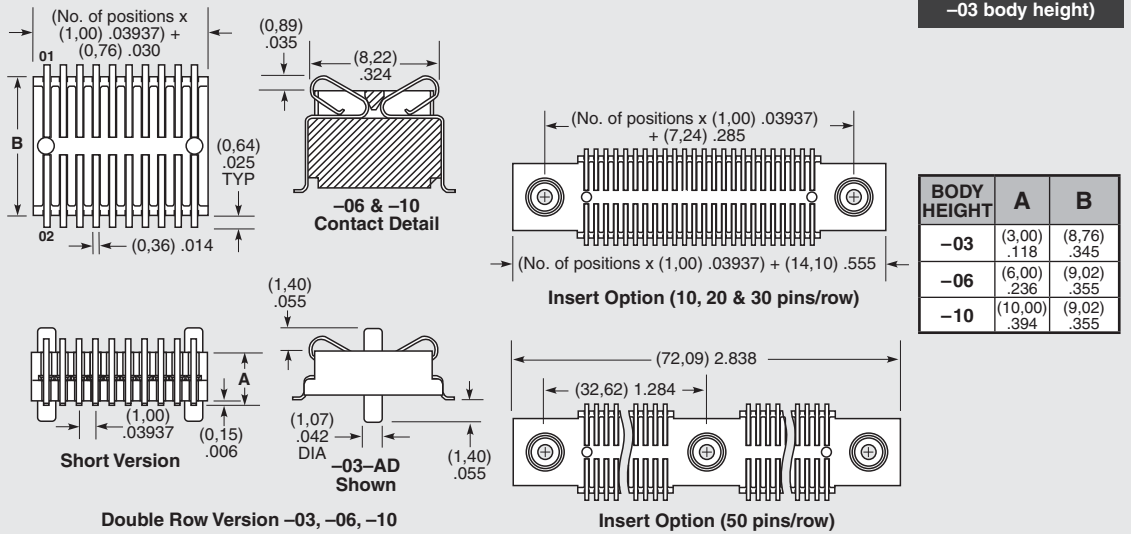

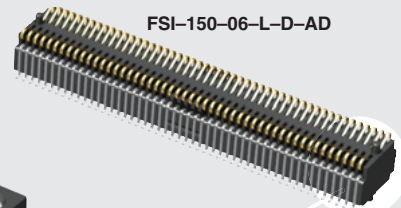
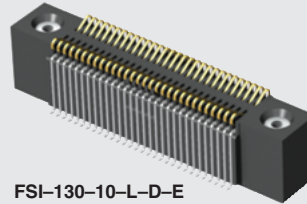
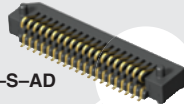
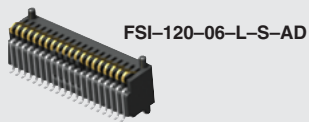

**FSI SERIES**

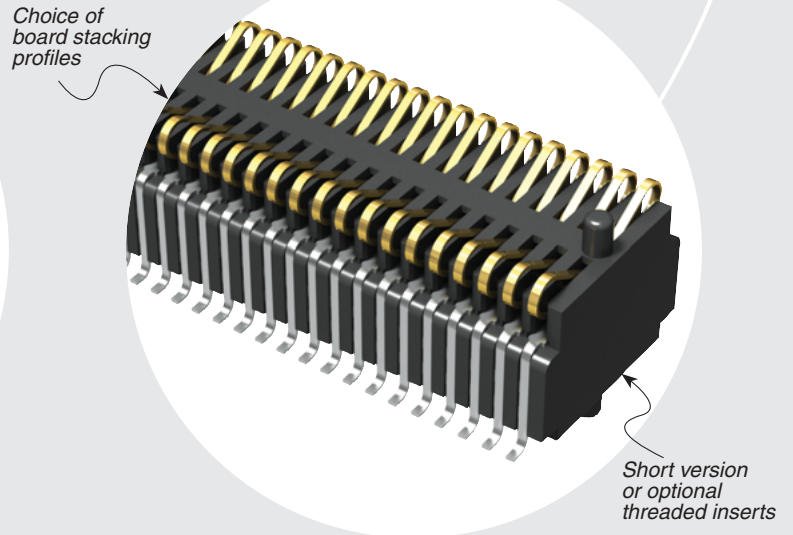
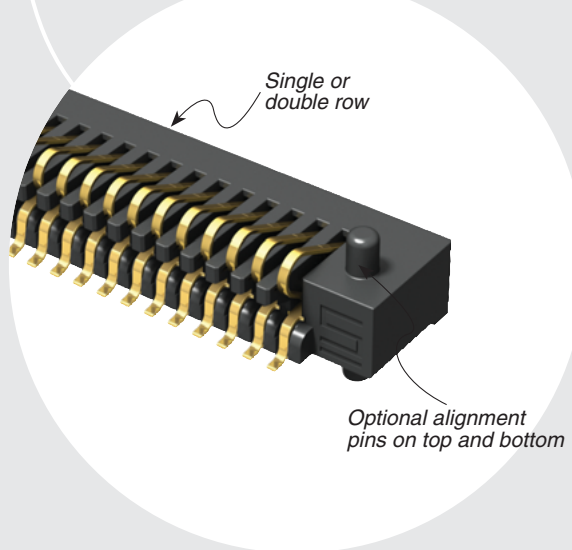

**ROW OPTION**

- S**  
= Single Row  
(Available with 5, 10 & 20 pins with -AD alignment pin)
- D**  
= Double Row

**INSERT OPTION**

- Leave blank for Short Version  
(No screw down inserts or holes)
- E**  
= #2-56 x 1/16" screw thread
- M**  
= 2,00 mm x 0,40 mm screw thread

**ALIGNMENT OPTION**

- Leave blank for no Alignment Pin
- AD**  
= Alignment Pin Top & Bottom

**OTHER OPTION**

- WT**  
= Weld Tab  
(Available with -S row option & -06 & -10 body height only)
- K**  
= Polyimide Film Pick & Place Pad  
(50 position with threaded insert option only)
- P**  
= Plastic Pick & Place Pad  
(5,08 mm) .200" x (12,45 mm) .490"  
(50 not available with -E)  
(Not available with -S row option or -03 body height)
- TR**  
= Tape & Reel Packaging

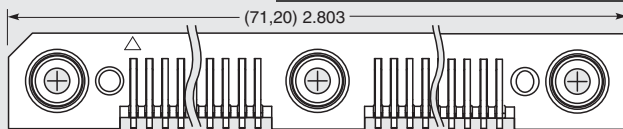

Insert Option (50 pins/row)

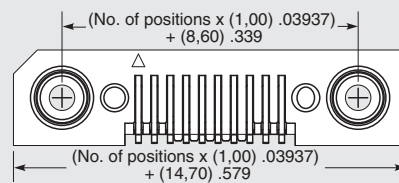
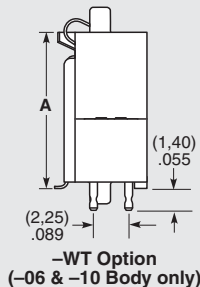
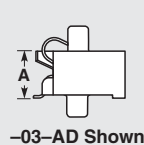
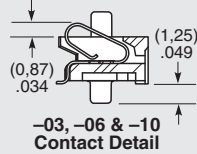
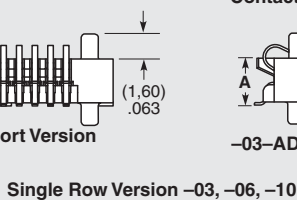
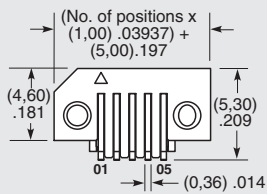

Insert Option (10, 20 & 30 pins/row)